

LAYING INSTRUCTION – INNOVATION CLICK

CHECK one | World of SPC

For the processing of vinyl floor coverings, the award and contract regulations for construction services (VOB), Part C, DIN 18365 (Germany) or the respectively valid standards for floor covering work, the generally recognised rules of the trade and the state of the art must be observed.

Before beginning installation of the flooring you must read the below instructions and follow throughout the installation process.

PREPARATION

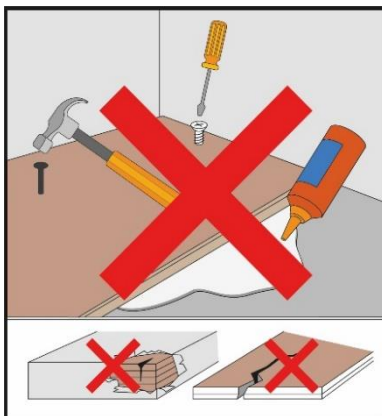

Despite regular quality controls, material defects can't be completely ruled out. Therefore, before installation our floor coverings must be thoroughly checked for batch equality (optical equality) and defects or damage. Recognisable defects can no longer be rectified after installation or cutting.

Note that the floor covering must not be screwed, glued or nailed.

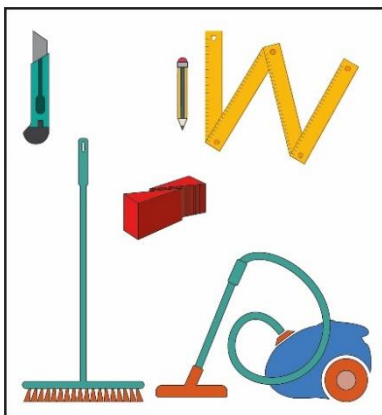

We recommend the use of the following tools for installation:

- Broom and/or vacuum cleaner
- Tape measure
- Pencil
- Set square and yardstick
- Stanley Knife

Measure the width of the room in advance and calculate how wide the last row of floorboards will be.

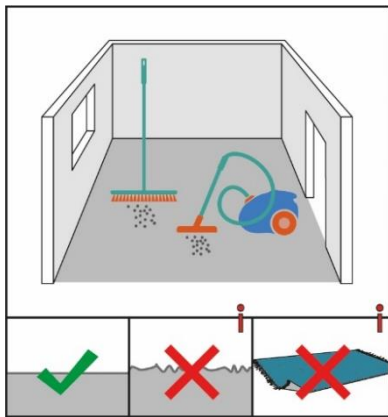

The substrate must be crack-free, clean, tension/compression resistant and completely dry (VOB, Part C, DIN 18365). Before laying, remove all old floor coverings from the subfloor as far as they may affect the evenness of the subfloor. The evenness of the substrate should not deviate by more than +/- 3 mm on 1 m (DIN 18202).

If necessary, have the subfloor checked by a floor layer.

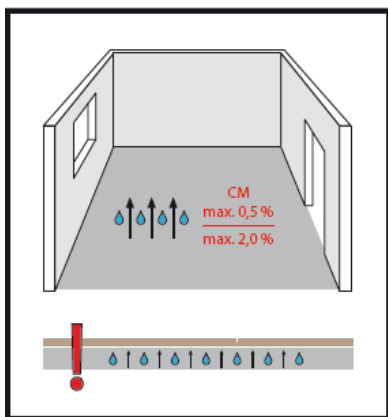

Check the humidity of the subfloor. The maximum permissible humidity for cement screed is 2.0%, for underfloor heating 1.8%. For anhydrite (calcium sulphate) screeds the maximum residual moisture is 0.5%, for underfloor heating max. 0.3%.

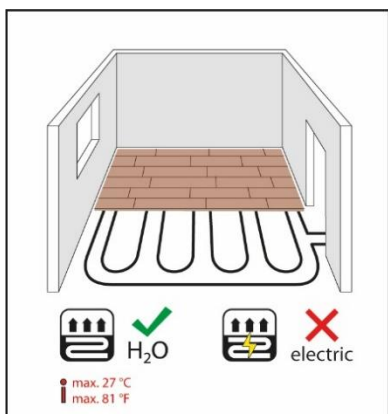

When laying on warm water underfloor heating systems, the screed must be produced in accordance with DIN18353 and heated to the required thickness (DIN EN1264 and DIN4725). The temperature on the surface of the flooring must not exceed 27°C.

Note: The floor covering is not suitable for electric underfloor heating.

Measure the space thoroughly beforehand. The length of the first panel may have to be adjusted to avoid a piece smaller than 30 cm. If necessary, the panels in the first row must also be shortened in width so that the last row

does not become too narrow (at least 5 - 8 cm) (formula: length of the area to be laid: the panel width).

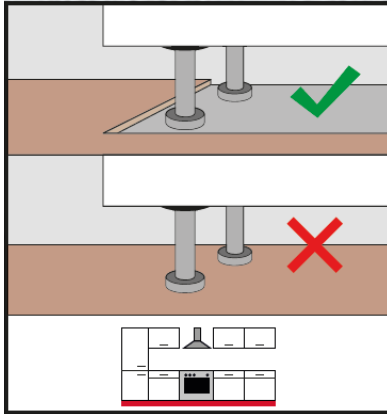

Kitchen must be set up before installation. Installation on the floor is not permitted.

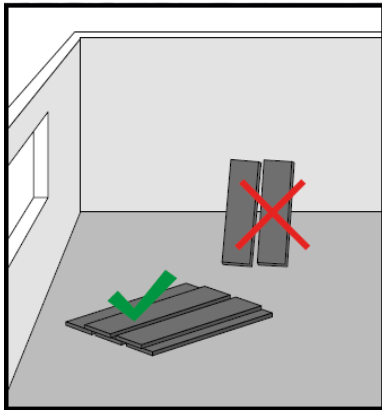

Note that the packages should never be stored upright, they should lie flat on the floor surface.

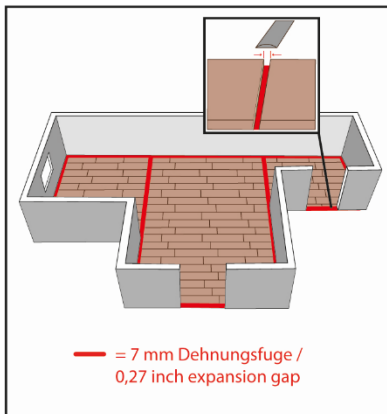

Before laying, you should plan for expansion or movement joints: All transitions to rooms or other floor coverings should be fitted with an expansion joint of at least 7 mm width. The same applies to larger areas, angled rooms, immovable components and areas such as walls, columns, door frames, stairs and heating pipes. If the substrate (e.g. screed) already has an expansion joint, you must also make an expansion joint in the vinyl floor at this point. **If the expansion or movement joint is omitted, the installer is liable.**

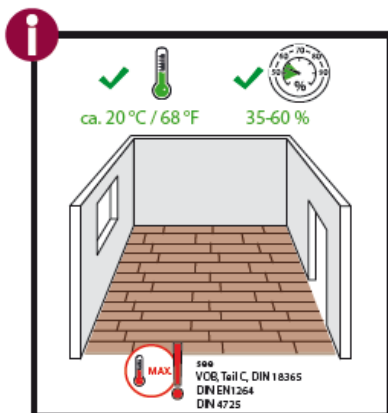

Please note that typical living room temperatures must prevail throughout the year (VOB, Part C, DIN 18365, DIN EN1264, DIN 4725). The room air temperature should be approx. 20°C, the relative humidity should be between 35-60%.

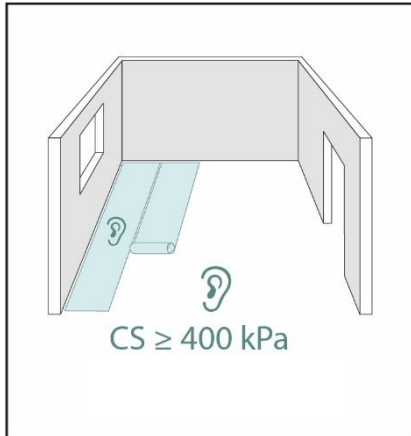

The use of a suitable impact sound insulation for vinyl floors is necessary. Please use an impact sound insulation with a pressure load of min. 400 kPa.

If the installation requires it, do not forget to use a vapour barrier.

If the product already has an integrated underlay, you can leave it out.

INSTALLATION

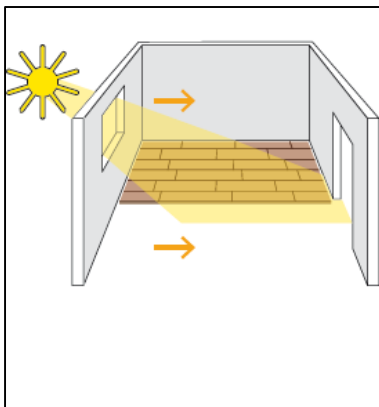

Lay the boards lengthwise to the main light source and thus towards the incoming light. The boards should be installed/laid from left to right. The boards must be floating.

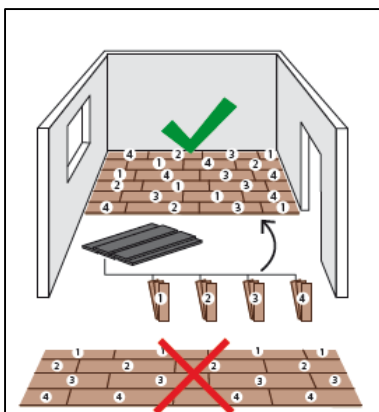

Before laying, check each individual board for colour and structure. It is advisable to mix several packages in order to obtain a uniform laying / sorting pattern.

Note: Only use material from the same batch in a room.

Measure the room thoroughly beforehand. The length of the first panel may have to be adjusted to avoid a piece smaller than 30 cm. It may also be necessary to shorten the width of the panels of the first row to avoid making the last row too narrow (at least 5 - 8 cm) (formula: length of the area to be laid: width of the panel).

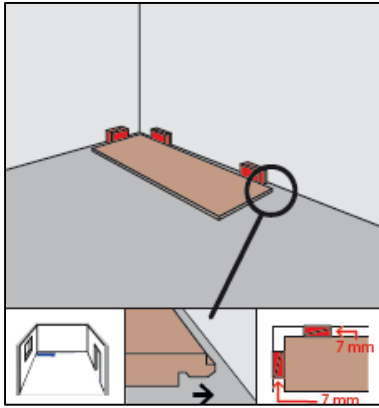

The first row is laid so that the spring of the head and long side faces the wall. Fix the first row with spacers (min. 7 mm) to the wall.

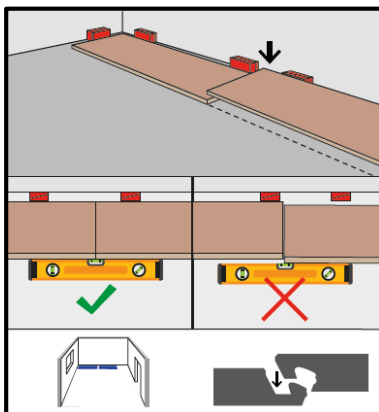

Click the second panel into the previous panel on the front side. This is done from above by gently pressing it in by hand until the click connection latches into place.

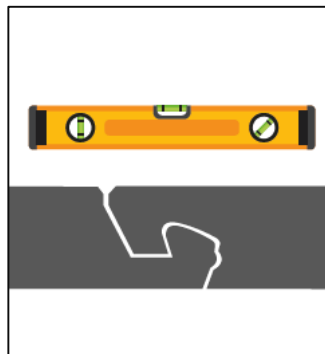
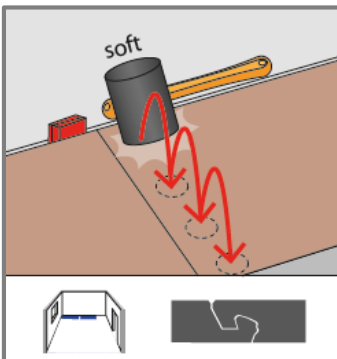

Then carefully knock into place using an acrylic hammer. This makes installation easier and ensures that the front-end connection is locked completely and accurately. Make sure that the panels are absolutely flush with each other.

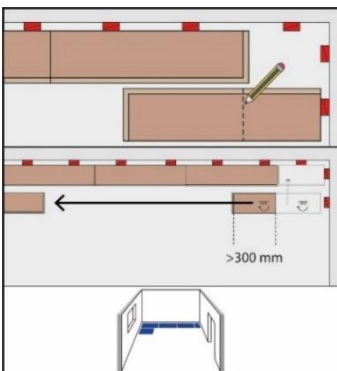

Start the next row with the remaining piece of flooring from the previous row. However, remnants should be at least 30cm long to ensure optimum stability.

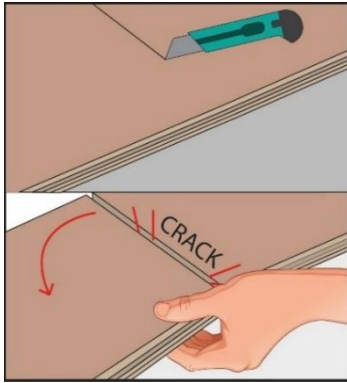

The custom-made panels are easily shortened with an angle and a carpet knife. Alternatively, you can also use a laminate cutter or a jigsaw. The panel is then "broken over the edge".

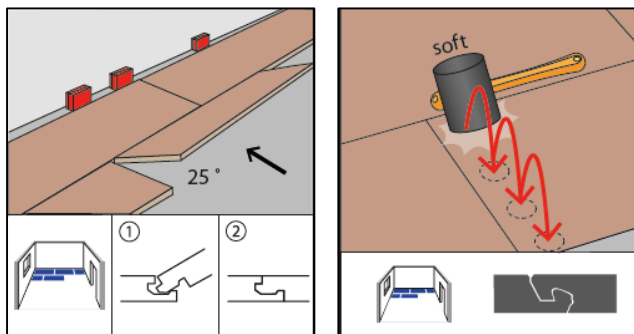

The first panel of the second row is attached to the first row by angling it along the long side. To do this, place the longitudinal tongue at an angle from above into the longitudinal groove of the first panel of the first row. Then lower the panel until it lies flat.

The second panel of the second row is clicked into the panel of the first row along the long side at an angle of max. 25°. This panel is then locked at the front-end by pressing it gently into the first panel of the second row. The previous panel may have to be raised slightly. With an acrylic hammer the planks are gently connected to each other.

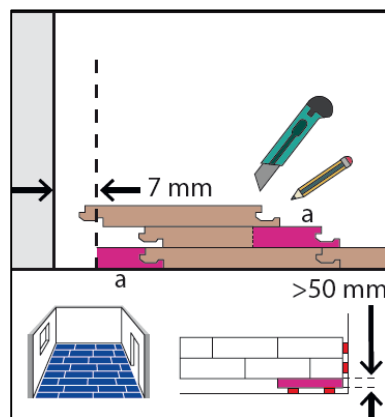

To install the last row of panels, you must also shorten the width (see picture on the left).

The width of the panels in the last row should be at least 5 cm.

Pay attention to the expansion joint.

SPECIALS

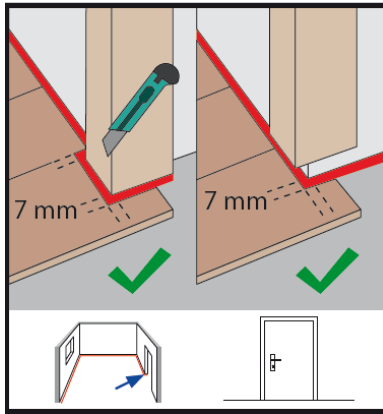

Wooden door frames can be shortened. Place a panel with the decor side down against the frame. Now shorten the door frame with a suitable saw along the panel. Then simply slide the panels under the door frame with the decor side up. In the case of door frames that cannot be shortened, cut the panel to size accordingly and observe the minimum 7mm circumferential distance for the expansion joints.

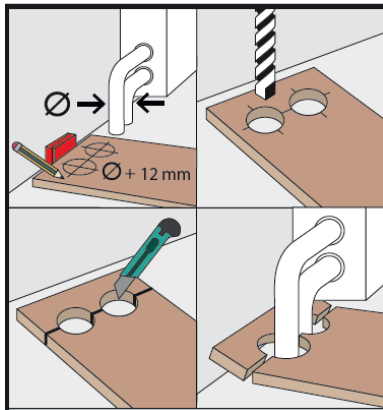

Where, for example, heating pipes protrude from the floor, please first cut the panel to the correct length, then place the panel piece next to the actual slot and measure and mark the cut-outs with a tape measure. Please always keep in mind the minimum distance of 7mm for the expansion joint. Now you can drill out the marked areas and saw the panel to size. Then place it behind the heating pipe and join it tightly with the panel.