

## LAYING INSTRUCTION – INNOVATION CLICK

CHECK one Herringbone

For the processing of CHECK one vinyl floor coverings, the award and contract regulations for construction services (VOB), Part C, DIN 18365 (Germany) or the respectively valid standards for floor covering work, the generally recognised rules of the trade and the state of the art must be observed.

Before beginning installation of the flooring you must read the below instructions and follow throughout the installation process.

### PREPARATION

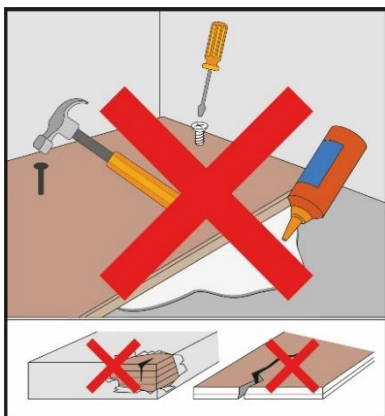

Despite regular quality controls, material defects can't be completely ruled out. Therefore, before installation our floor coverings must be thoroughly checked for batch equality (optical equality) and defects or damage. Recognisable defects can no longer be rectified after installation or cutting.

**Note that the floor covering must not be screwed, glued or nailed.**



We recommend the following tools for installation:

- Broom / vacuum cleaner
- Tape measure / ruler
- pencil
- Drawing angle and measuring stick
- Carpet knife / jigsaw if necessary
- Glue
- Rubber hammer
- Optional: possibility of jacking up

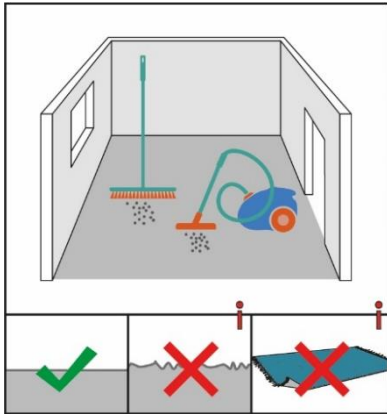

The substrate must be crack-free, clean, tension/compression resistant and completely dry (VOB, Part C, DIN 18365). Before laying, remove all old floor coverings from the subfloor as far as they may affect the evenness of the subfloor. The evenness of the substrate should not deviate by more than +/- 3mm on 1m (DIN 18202).

**If necessary, have the subfloor checked by a floor layer.**

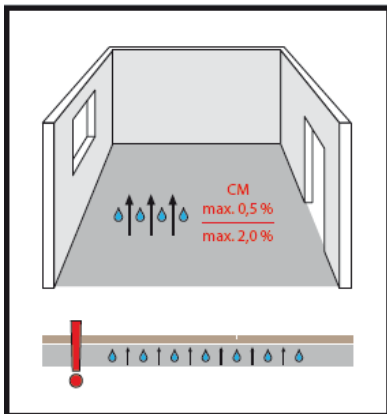

Check the humidity of the subfloor. The maximum permissible humidity for cement screed is 2.0%, for underfloor heating 1.8%. For anhydrite (calcium sulphate) screeds the maximum residual moisture is 0.5%, for underfloor heating max. 0.3%.

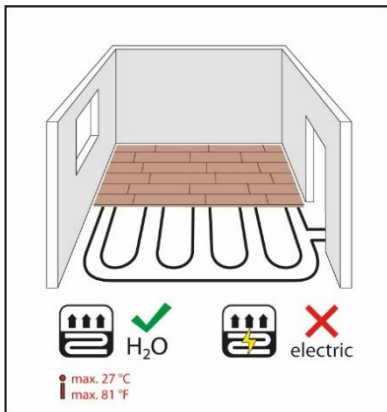

When laying on warm water underfloor heating systems, the screed must be produced in accordance with DIN18353 and heated to the required thickness (DIN EN1264 and DIN4725). The temperature on the surface of the flooring must not exceed 27°C.

**Note: The floor covering is not suitable for electric underfloor heating.**

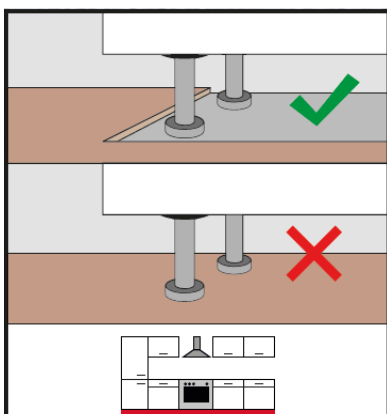

Kitchen must be set up before installation. Installation on the floor is not permitted.

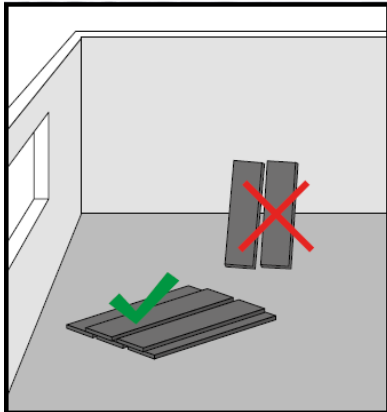

Note that the packages should never be stored upright, they should lie flat on the floor surface.

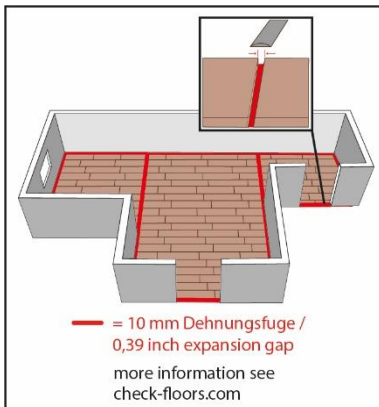

Before laying, you should plan for expansion or movement joints: All transitions to rooms or other floor coverings should be fitted with an expansion joint of at least 10 mm width. The same applies to larger areas, angled rooms, immovable components and areas such as walls, columns, door frames, stairs and heating pipes. If the substrate (e.g. screed) already has an expansion joint, you must also make an expansion joint in the vinyl floor at this point. **If the expansion or movement joint is omitted, the installer is liable.**

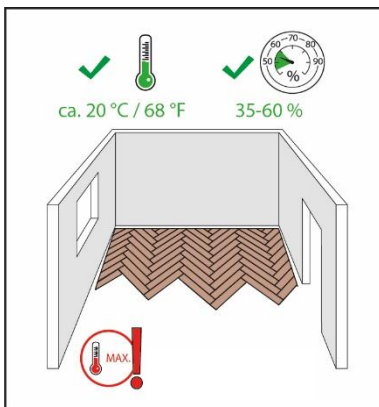

Please note that typical living room temperatures must prevail throughout the year (VOB, Part C, DIN 18365, DIN EN1264, DIN 4725). The room air temperature should be approx. 20°C, the relative humidity should be between 35-60%.

## INSTALLATION

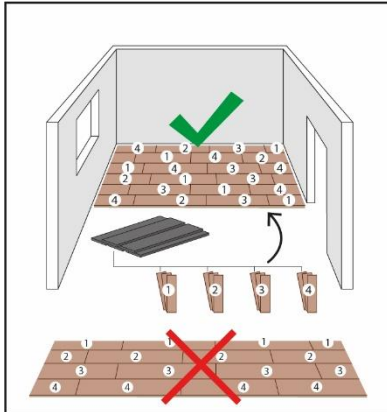

Before laying, check each individual board for colour and structure. It is advisable to mix several packages in order to obtain a uniform laying / sorting pattern.

**Note: Only use material from the same batch in a room.**

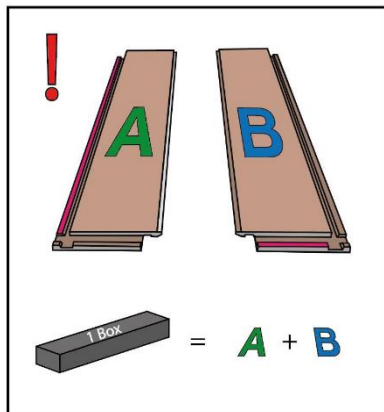

Two different types of panels are used to install the herringbone pattern. These panels are referred to as A- and B-panels. Each box contains A and B planks. To differentiate between them, the A-panels are marked on the back side.

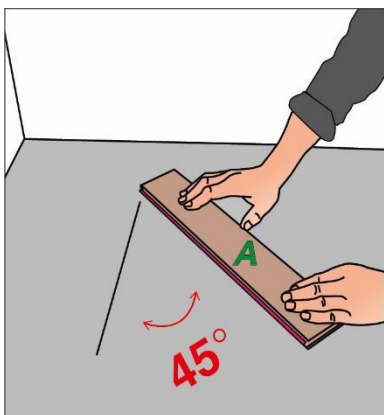

Choose a wall to start at and begin installing at the left corner. Start with an A-panel and place it with its long side marking facing the left wall at an angle of 45 degrees. Make sure that the distance between the left wall and the panel is less than the length of the panel.

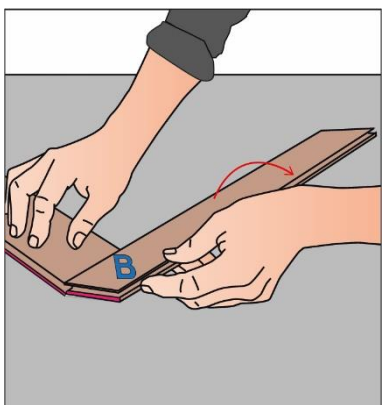

Continue with a B-panel. Press the long side of the B-panel at an angle against the short side of the previous installed A-panel. Fold down the B-panel flat to the floor to lock the panels tightly together. Check that the panels form a continuous line.

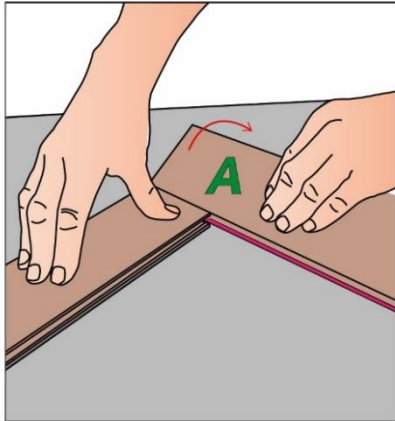

Next panel is an A-panel. Again, press the long side of the new A-panel at an angle against the short side of the previous B-panel and fold down. Continue like this as many panels as may fit along the starting wall.

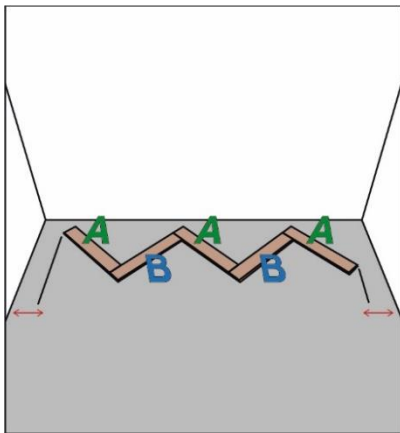

Check the first row of panels is centered along the starting wall. Make sure that the distance to the walls on both sides are less than the length of one panel. If not, add a panel at the right side.

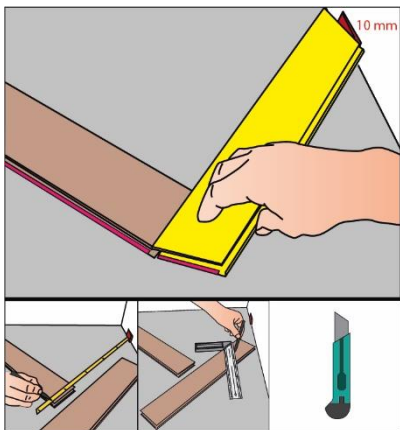

Measure and cut the end panels to size using a fine-toothed saw. Finish the first row with the cut end panels. Make sure that you leave a gap of 10 mm to each wall.

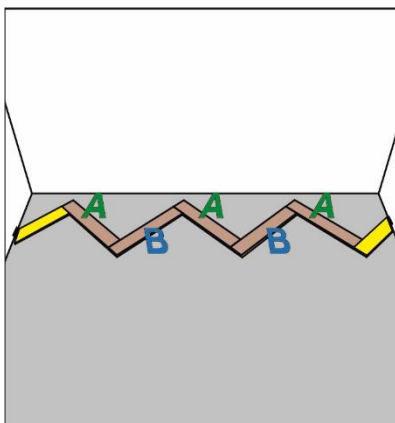

The first row is completely laid.

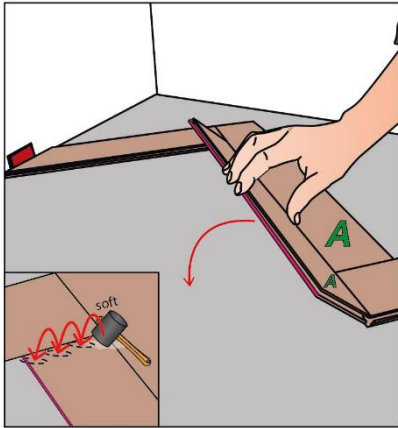

Start the next row with an A-panel. Place the new panel against the previous row and fold down. To do this, press down on the short side of the plank so that the click connection engages completely. If necessary, tap lightly with a rubber hammer.

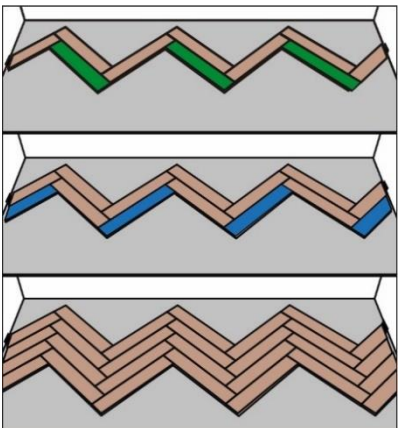

Continue from the left to the right and install all the A-panels in the second row. Now work in the opposite direction, from the right to the left and install all the B-panels in the second row. To do this, press down on the short side of the plank until it engages completely. Finish with a piece of panel cut to size. Install additional rows to complete four full rows.

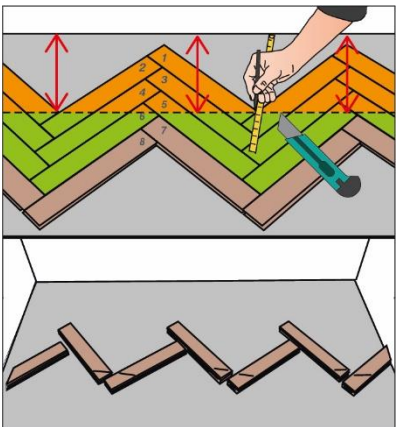

Version 1

The first rows have to be cut parallel to the wall. The planks, which are marked green in the picture, are required. Measure and mark where to cut the floor panels at a fixed/parallel distance to the wall. Number the panels from 1 to 8. This will allow you to keep the panels in order. The planks, which are marked orange in the picture, are required in the last row. Dismantle the panels and cut them to size along the previous marked line.

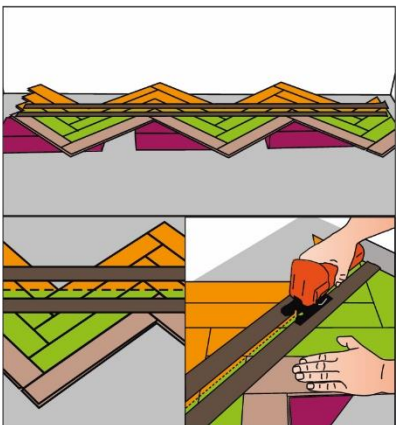

Version 2

Leave the end-panels uninstalled. Tape along the marked line and place the flooring on top of a few flooring packages. Cut along the marked line with a jigsaw. Make sure that the click connections don't loose.



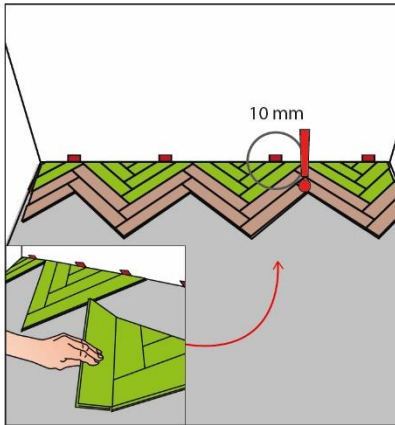

Put the adjusted rows (in the picture green marked) into place. If you use version 1, connect the cut starting panels to form triangular shapes. Start installing the triangles from the left corner. It is recommended to use glue to fix the smallest parts (click-connections) of the triangles. Make sure that you leave a gap of 10 mm to the wall.

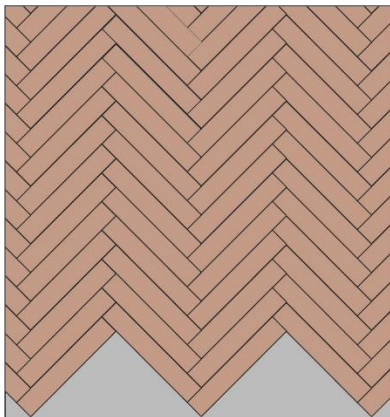

Continue the rows until you have reached the last row.

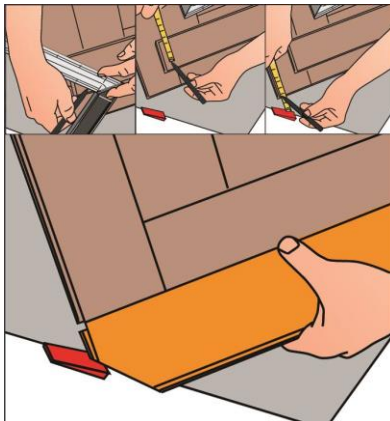

For the last row you need the planks from the first four rows (orange marked in the picture). Optionally you have to measure and cut the panels.

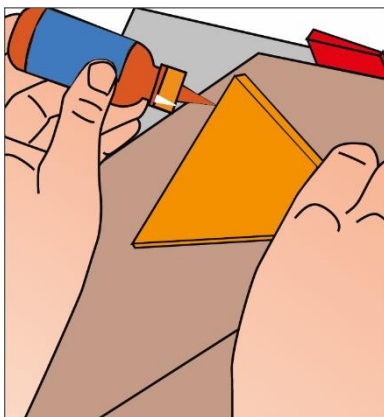

It is recommended to use glue for the click-connections to install the smallest pieces of panels.

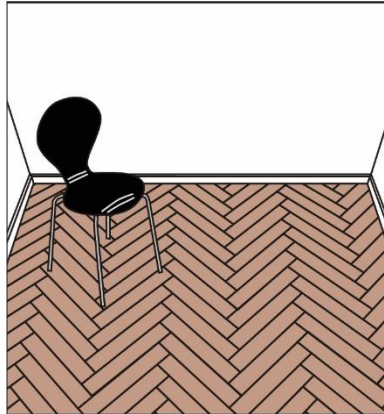
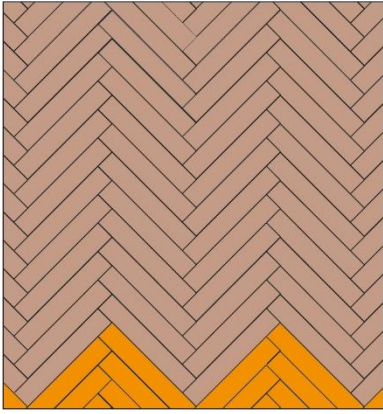

The herringbone floor is completely laid.

## MORE OPTIONS

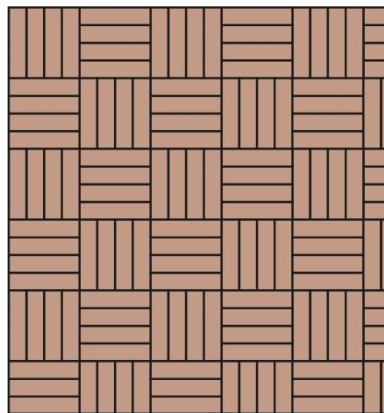
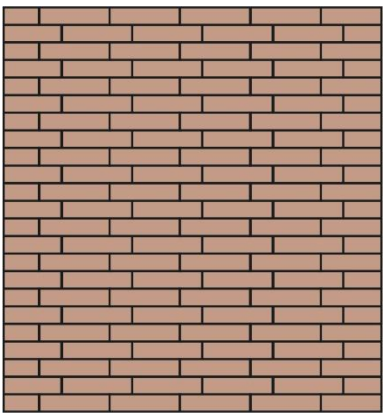



## SPECIALS

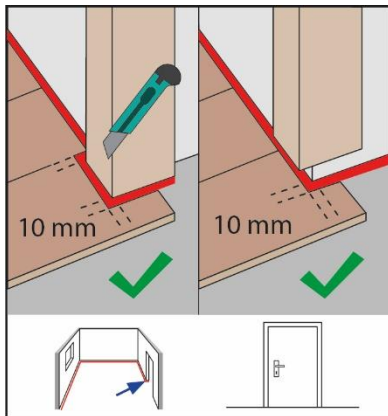

Wooden door frames can be shortened. Place a panel with the decor side down against the frame. Now shorten the door frame with a suitable saw along the panel. Then simply slide the panels under the door frame with the decor side up. In the case of door frames that cannot be shortened, cut the panel to size accordingly and observe the minimum 10 mm circumferential distance for the expansion joints.

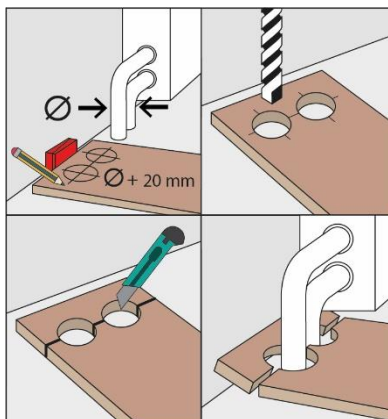

Where, for example, heating pipes protrude from the floor, please first cut the panel to the correct length, then place the panel piece next to the actual slot and measure and mark the cut-outs with a tape measure. Please always keep in mind the minimum distance of 10 mm for the expansion joint. Now you can drill out the marked areas and saw the panel to size. Then place it behind the heating pipe and join it tightly with the panel.